

MiMo Directional 3.6/5.0GHz Antenna

WMM[X]9G-36-55-NJ



WMM[X]9G-36-55-NJ

- Supports 2x2, 3x3 or 4x4 MiMo across 3.4-3.8/5.0GHz
- Up to 4x wideband elements with gain
- Suitable for mast and rail mounting

The WMM[X]9G-36-55 is a high directional gain 2x2, 3x3 or 4x4 MiMo antenna for 5G / CBRS / private LTE networks. Incorporating two, three or four separately fed gain element assemblies in a single housing the WMM[X]9G-36-55 is equipped to provide client-side MiMo support for 3.6 and 5.0GHz networks.

The weather-resistant housing is designed for rail or mast mounting. Supplied with fitted N female bulkhead connections for easy installation the product can be fitted with a range of extension cables. The product range is certified to both IP66 and IK10 ideal for external or internal use in tough environments.

The WMM[X]9G-36-55 is a cost-effective value-added product for providing MiMo 3.6/5.0GHz coverage to a room, platform or other areas.

Technical Drawing

WMM49G-36-55-NJ Shown

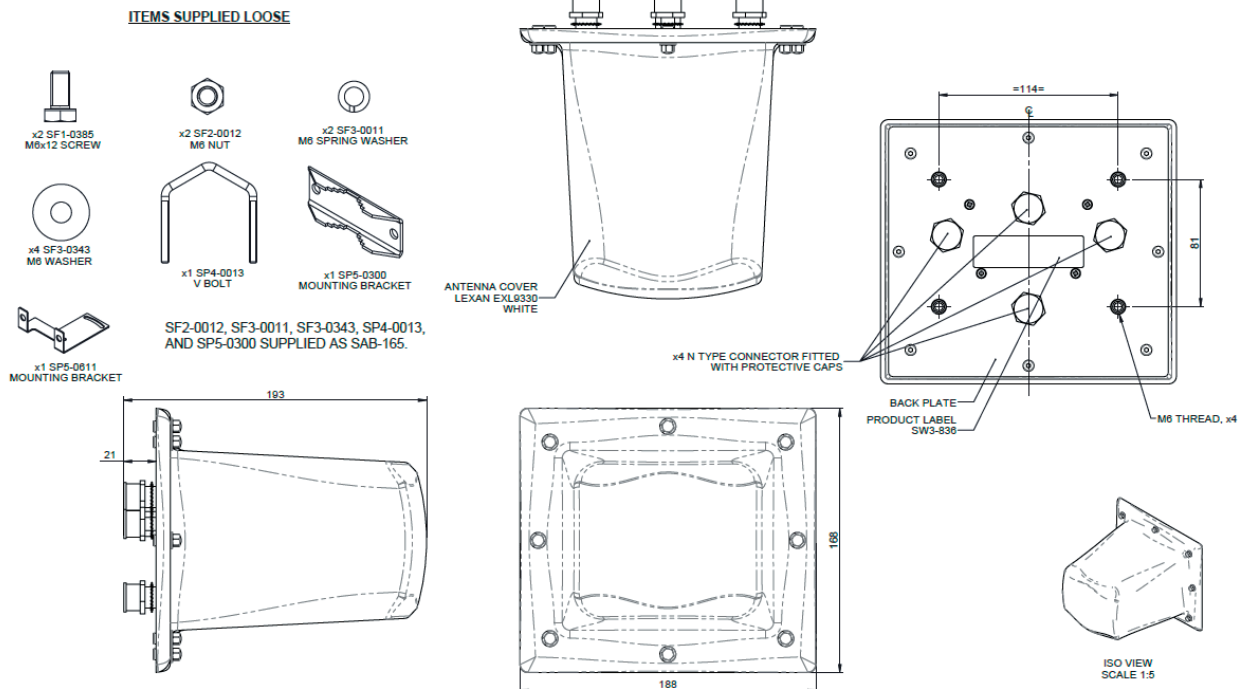

MiMo Directional 3.6/5.0GHz Antenna

WMM[X]9G-36-55-NJ

PANORAMA ANTENNAS

Product Data

Part No.		WMM49G-36-55-NJ	WMM39G-36-55-NJ	WMM29G-36-55-NJ
Electrical Data				
Frequency range (GHz)		4x 3.4-3.8 / 4.9-5.0	3x 3.4-3.8 / 4.9-5.0	2x 3.4-3.8 / 4.9-5.0
Operational bands		4x 3.6/5.0GHz	3x 3.6/5.0GHz	2x 3.6/5.0GHz
Radiation pattern		Directional		
Nominal polarisation		2x Horizontal 2x Vertical	1x Horizontal 2x Vertical	1x Horizontal 1x Vertical
Peak gain (excl cable loss)+	3.4-3.8 GHz	9dBi		
	5-6 GHz	9dBi		
Typical 3dB beamwidth θ +	3.6 GHz H Plane	60		
	5.4 GHz H Plane	65		
	3.6 GHz E Plane	55		
	5.4GHz E Plane	50		
Efficiency - excluding cable loss (all bands)		> 60%		
Correlation co-efficient (all bands)		< 0.2		
Max input power (W)		20 Watts		
Nominal impedance		50 Ω		
Mechanical Data				
Dimensions (mm)	Height	168 (6.6")		
	Width	188 (7.4")		
	Depth	193 (7.6")		
Operating temp (°C)		-40° / +80°C (-40° / 176°F)		
Material		Lexan EXL 9330		
Colour		White		
Ingress Protection		IP66		
Vandal Resistance		IK10		
Weight (g)		1250	1185	1120
Mounting Data				
Fixing		Rail mount / mast mount		
Mounting bracket material		Stainless steel / Aluminium		
Pole diameter (mm)		20-50 / (0.78 - 1.96")		
Connector Data				
Type		N female x 4	N female x 3	N female x2

+Peak gain and beamwidth data for each element measured individually based on a vertically polarised element

Electrical Data

Typical VSWR*

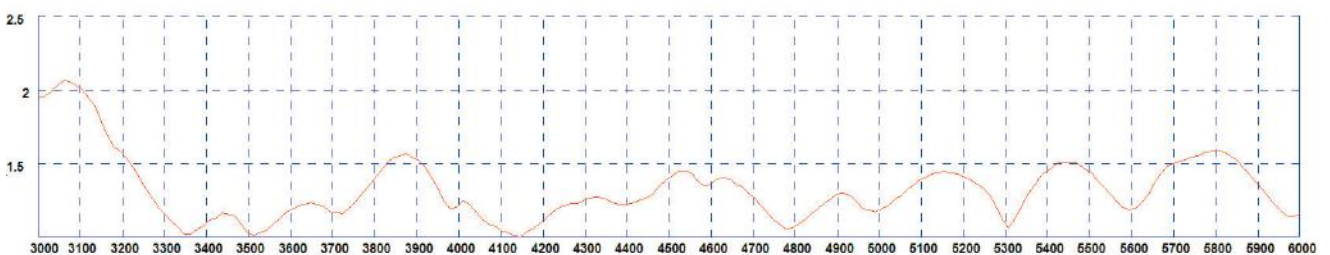

*VSWR of typical element measured in free space without cable

MiMo Directional 3.6/5.0GHz Antenna

WMM[X]9G-36-55-NJ

Electrical Data - Cell

Typical Isolation **

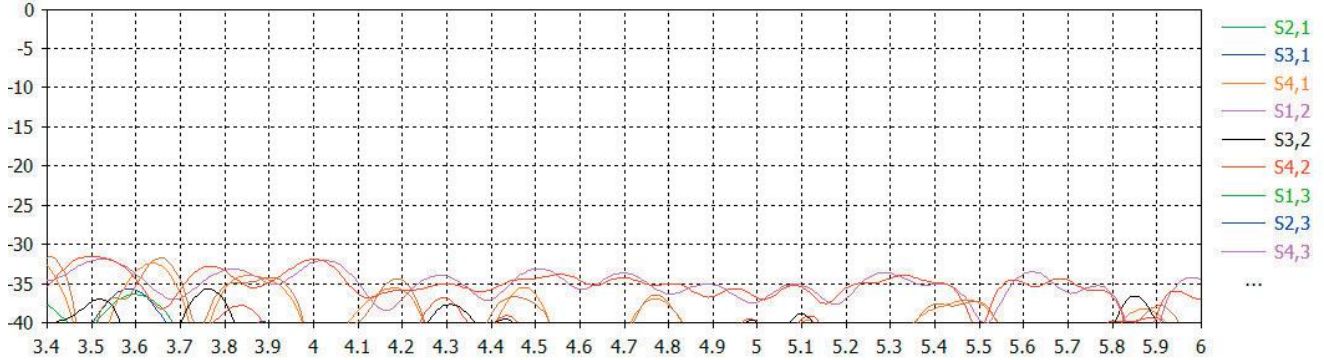

**Isolation measured in free space without cable.

Typical Swept Peak Gain ***

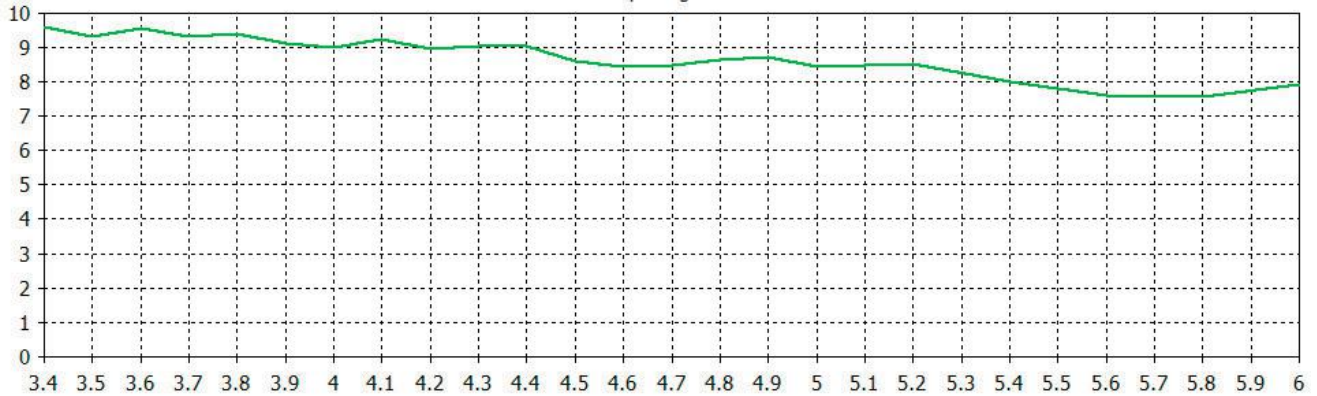

*** Swept peak gain simulated in CST Microwave studio for each element excluding cable loss

Typical Efficiency ****

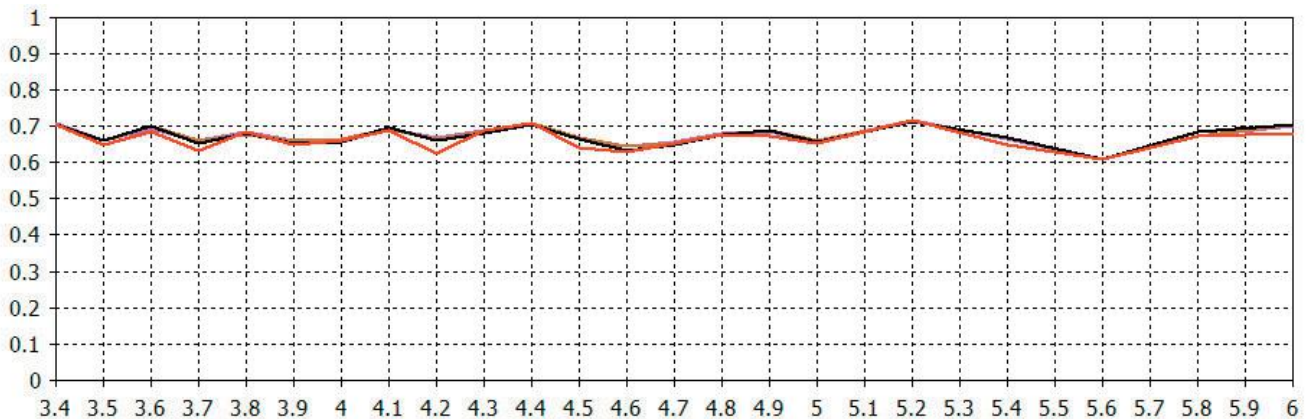

**** Efficiency simulated in CST Microwave studio for each element excluding cable loss

MiMo Directional 3.6/5.0GHz Antenna

WMM[X]9G-36-55-NJ

* Patterns simulated in CST Microwave studio based on 4x Elements fed together

Pattern Data 4x
Elements

Typical 3D Pattern 3.6GHz*

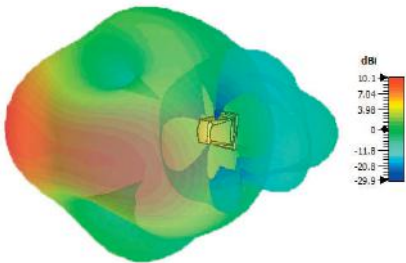

Typical E Plane Pattern 3.6GHz*

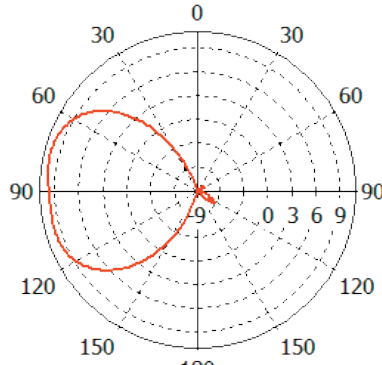

Typical H Plane Pattern 3.6GHz*

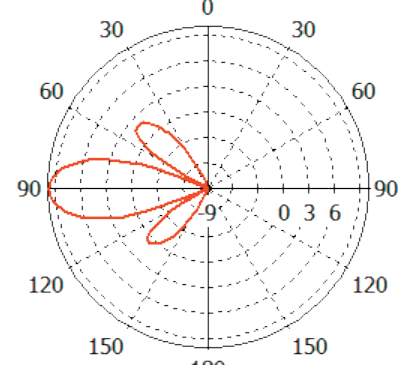

Typical 3D Pattern 5.4GHz*

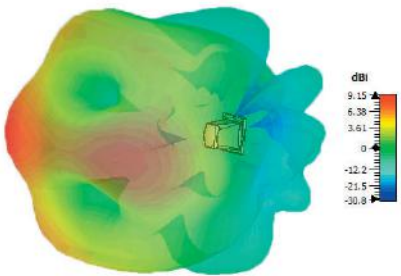

Typical 3D E Plane Pattern 5.4GHz**

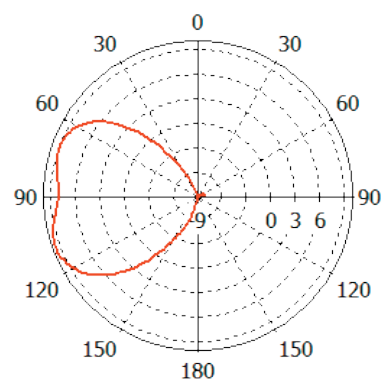

Typical H Plane Pattern 5.4GHz**

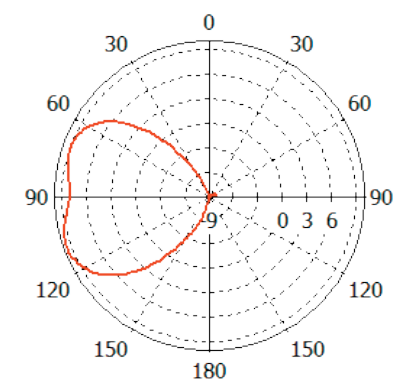

** Patterns simulated in CST Microwave studio based on one vertical element fed

Pattern Data Each
Element

Typical 3D Pattern 3.6GHz**

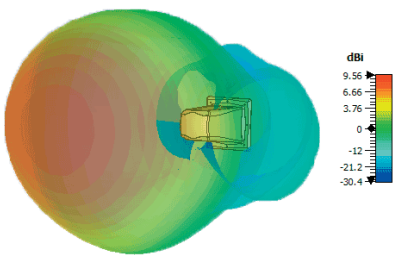

Typical E Plane Pattern 3.6GHz**

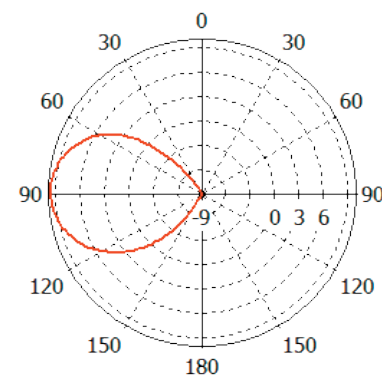

Typical H Plane Pattern 3.6GHz**

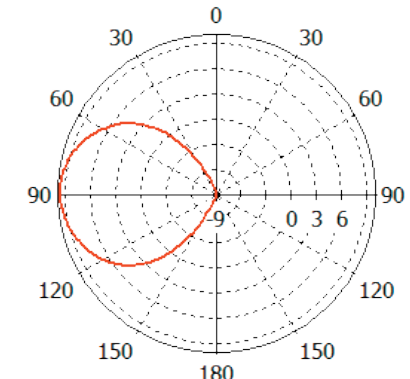

Typical 3D Pattern 5.4GHz**

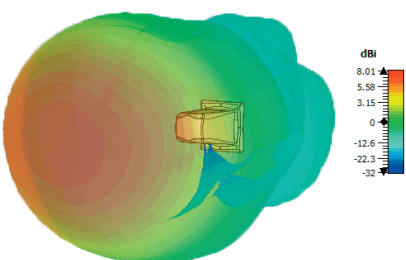

Typical 3D E Plane Pattern 5.4GHz**

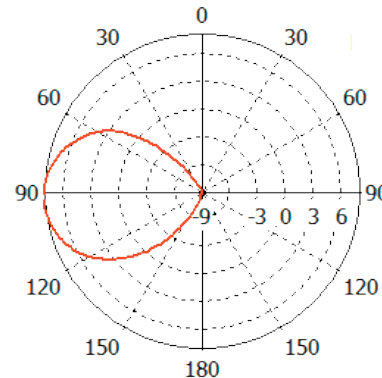

Typical H Plane Pattern 5.4GHz**

