

Ultra Compact MiMo 3.6/5GHz Antenna

LPPM[X]-36-55-[VAR]



LPPM[X]-36-55-[VAR]

- Ultra Compact
- Dual Band Private LTE / CBRS 3.6/5.0
- Up to 4 x 4 MiMo

The LPPM[X]-36-55 range has been designed to provide MiMo dual band 3.6/5.0GHz coverage for private LTE / CBRS in an ultra low profile package. The compact, robust low-profile housing contains up to four antenna elements with effective isolation and low correlation covering 3.4-3.8/4.9-6GHz.

The antenna is designed to be panel mounted and can be fitted on a conductive or non- conductive panel. Supplied with integrated RG174 cable the antenna is suitable for many environments.

Technical Drawing

LPPM-36-55-2SP

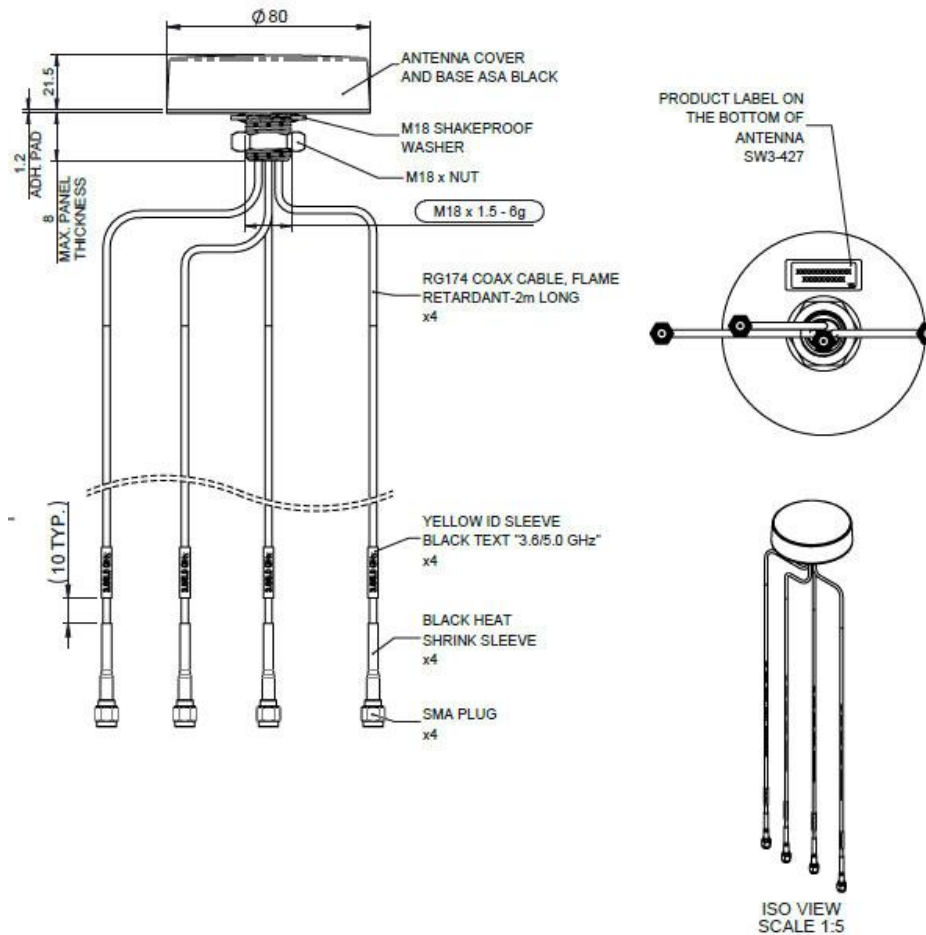

Ultra Compact MiMo 3.6/5GHz Antenna LPPM[X]-36-55-[VAR]

Product Data

Part No.

LPPM4-36-55-2SP

Electrical Data

		4x 3.6/5.0GHz
Peak Gain	3.4-3.8GHz	2dBi
Isotropic †	4.9-6.0GHz	4dBi
Typical VSWR*		< 2:1
Typical Isolation*		>20dB
Pattern		Omni-directional
Nominal Impedance		50Ω
Max input power (W)		10

Mechanical Data

Dimensions (mm)	Diameter	80 (3.15")
	Height	21.5 (0.85")
Operating Temp (°C)		-30° / +70°C (-30° / 158°F)
Material		ASA
Colour		Black
IP Rating		IP66 / IP69K**
Typical Weight		170g

Mounting Data

Fixing	Panel Mount - 18mm (3/4")
--------	---------------------------

Cable Data

WiFi Cables	Cable Type	FR RG174
	Diameter	3mm (0.1")
	Length	2m (6')
	Termination	SMA (m)

Electrical Data

Typical VSWR - Elements 1-4*

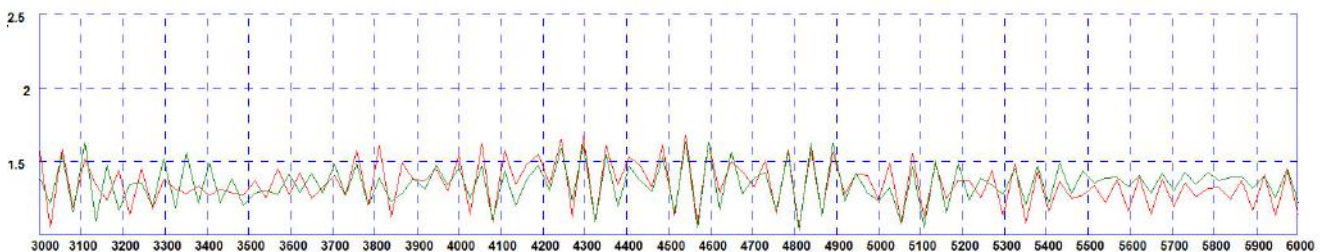

* VSWR measured with 2m (6') of RG174 cable in free space - RED TRACE and on a 600x600mm Ground plane - GREEN TRACE

† Peak gain simulated with all elements fed in free space excluding cable loss

* Typical Isolation and VSWR stated as measured in free space with 2m (6') of cable

**When installed in accordance with SW3-996

Ultra Compact MiMo 3.6/5GHz Antenna

LPPM[X]-36-55-[VAR]

Electrical Data

Typical VSWR Elements 1-4*

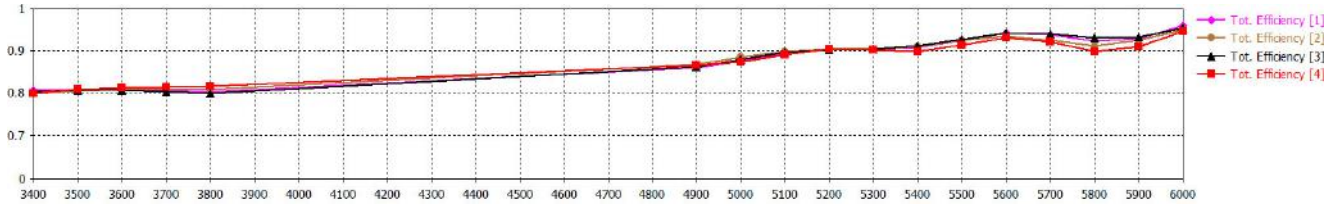

*Efficiency simulated in CST Microwave Studio in free space without cable

Typical Isolation*

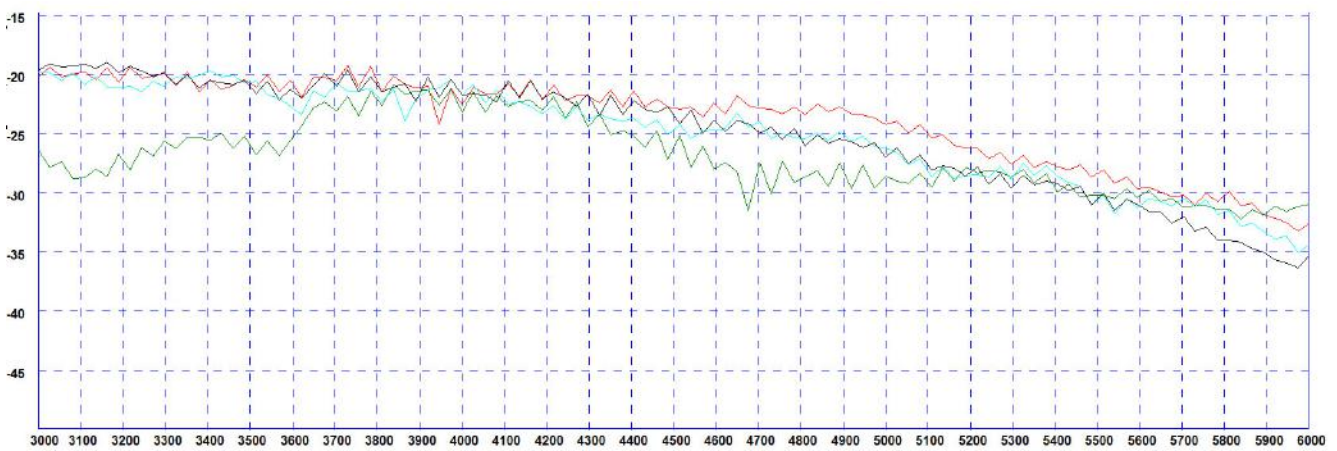

*Typical Isolation measured with 2m RG174 cable in free space Red Trace = elements 1-2 Green Trace= Elements 1-3 Blue Trace = Elements1-4 Black Trace = Elements 2-3

Pattern Data

Typical 3D Pattern Ground Plane (3600MHz)

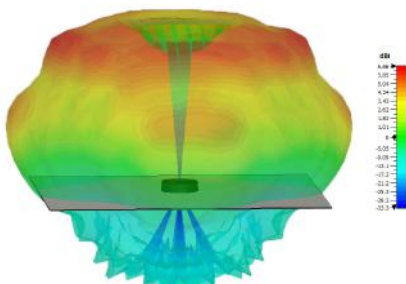

Typical 3D Pattern Ground Plane (5400MHz)

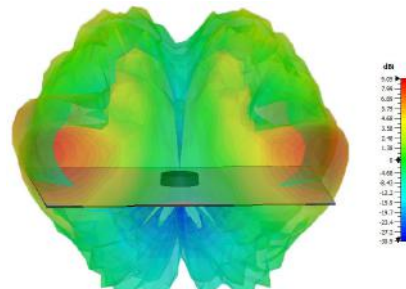

Typical 3D Pattern Free Space (3600MHz)

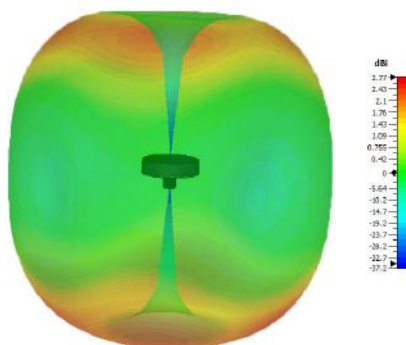

Typical 3D Pattern Free Space (5400MHz)

