

PCM-24D2R2-BE PCM-24D2R4-BE PCM-24D4R2-BE PCM-24D4R4-BE

2-Port Isolated RS-232, mPCIe, DB9

2-Port Isolated RS-422/485, mPCIe, DB9

4-Port Non-Isolated RS-232, mPCIe, DB37 cable

4-Port Non-Isolated RS-422/485 mPCIe, DB37 cable

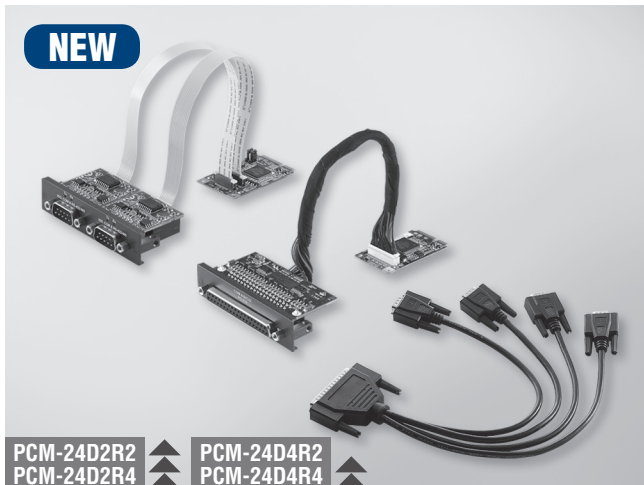

PCM-24D2R2
PCM-24D2R4

PCM-24D4R2
PCM-24D4R4



Features

- Meets Advantech iDoor Technology Standard
- Speeds up to 921.6 kbps for extremely fast data transmission
- Supports any baud rate setting (200 bps ~ 921.6 kbps)
- The PCM-24D2Rx (2 ports RS233/422/485) supports Isolated Protection
- Supports Win7/Win10
- Supports Embedded Automation PC UNO-2200/2300/2400 series
- Supports Control DIN-Rail PC UNO-1200/1300/1400 series
- Supports Control Cabinet PC UNO-3200/3300/3400 series
- Supports Control Panel Computers TPC-xx81/xx82 series
- Supports Thin Client Panel Computers TPC-xx51 series

Introduction

The PCM-24 series are categorized as communication modules from Advantech iDoor Technology. It includes Isolated / Non-Isolated RS-232/422/485 communication cards for automation control, Wi-Fi/3G/GPS/GSM/LTE wireless communication modules for data exchange during the management and machine level of automation application and PoE function for smart camera in detect inspection application of production. The iDoor Technology increases the flexibility to configure the required features for different application.

Specifications

General

- Bus Type** mini PCIe
- Host Interface** USB2.0
- Certification** CE, FCC class A
- Connectors** 2 x Male DB9 for PCM-24D2xx
1 x Female DB37 for PCM-24D4xx
- Dimensions** Module: 51 x 30 x 12.4 mm (2" x 1.18" x 0.49")
I/O Plate: 81 x 19.4 x 41 mm (3.19" x 0.76" x 1.61")
- Power Consumption** 400 mA @ +3.3 V for PCM-24D2xx
500 mA @ +3.3 V for PCM-24D4xx

Communications

- Data Bits** 5, 6, 7, 8
- Data Signals** RS-232: TX, RX, RTS, CTS, DTR, DSR, DCD, DI, GND
RS-422: TX+, TX-, RX+, RX-, (PCM-24D4R4)
TX+, TX-, RX+, RX-, CTS+, CTS-, RTS+, RTS- (PCM-24D2R4)
RS-485: Data+, Data-
4K bytes
- FIFO** RTS/CTS (PCM-24D4R4 not supported)
- Flow Control** Odd/Even/Mark/Space/No Parity
- Parity** 200 bps ~ 921.6 kbps (PCM-24D2R4 & PCM-24D4R4)
- Speed** 230.4 kbps (PCM-24D2R2 & PCM-24D4R2)
1/2 stop bits
- Stop Bits** 1/2 stop bits

Protection

- Isolation Protection** 2,000 V_{DC} for PCM-24D2xx only
- ESD Protection** 15 KV
- EFT Protection** 2,500 V
- Surge Protection** 1,000 V_{DC}

Software

- OS Support** Microsoft® Windows® 7/10

Environment

- Humidity (Operating)** 5-95% RH, non-condensing
- Operating Temperature** -20 ~ 60°C (-4 ~ 140°F)
- Storage Temperature** -40 ~ 85°C (-40 ~ 185°F)

Dimensions

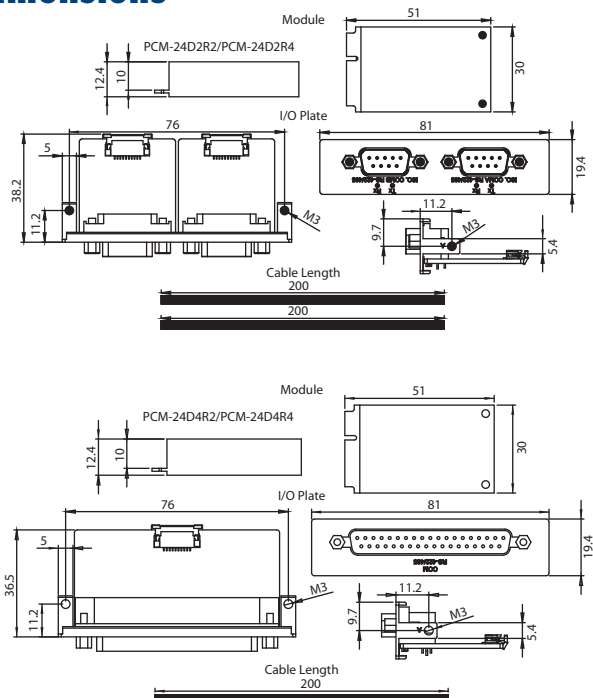

Ordering Information

- * **PCM-24D2R2-BE** 2-Port Isolated RS-232 mPCIe, DB9 x 2
- * **PCM-24D2R4-BE** 2-Port Isolated RS-422/485 mPCIe, DB9 x 2
- * **PCM-24D4R2-BE** 4-Port Non-Isolated RS-232 mPCIe, DB37 x 1
- * **PCM-24D4R4-BE** 4-Port Non-Isolated RS-422/485 mPCIe, DB37 x 1

Note: PCM-24D4R2-BE and PCM-24D4R4-BE include a "DB37(male) to 4 x DB9(male)" cable 1700021869-01