



## Main Features

- Built-in NVIDIA® Jetson AGX Orin™ SOM, up to 200/275 TOPS (INT8) performance
- Designed to be fanless, rugged, and compact
- 6-port GbE PoE+ (X-coded) for IP CAM/LiDAR sensors, optional 1-port 10GbE (X-coded)
- HEVC/H.265 hardware DECODE, supporting up to 7 x 4K30
- Wide range operating temperature of -25°C~70°C
- Ultra-speed PCIe 4.0 x4 NVMe SSD for data integrity
- Expansive for GNSS, LTE/5G NR & Wi-Fi 5/6
- 24V DC-IN for rail, ignition control & OCP/OVP
- NEXCOM Acceleration Linux (NAL) integrated w/ JetPack 5.1.1
- Military standard of MIL-STD-810H for anti-vibration/shock
- CE/FCC, UKCA, EN50155 (EN55011, EN50121-3-2, EN61373, OT4) Certified

## Product Overview

AI has become an essential component of automated vehicle technologies. With its built-in high performance NVIDIA® Jetson AGX™ Orin SOM, the ATC 3750-A6CR can deliver up to 200/275 TOPS workload on Artificial Intelligence (AI) processing and inference, supporting applications such as ADAS in Transportation/Construction, ANPR, AMR, Machine Learning (ML), ITS and factory automation.

Thanks to NEXCOM excellent thermal solutions, ATC 3750-A6CR can working through its defined TDP (15W~60W) at the harsh environments without fan kit to achieve 200/275 TOPS workload performance.

The ATC 3750-A6CR is a rugged, compact-size in-vehicle AI powered computer that features 24VDC (power isolation) with IGN control, 6 PoE+ (X-coded) for accessing IP CAM/LiDAR sensors, and rich peripheral ports, USB 3.2, isolation CANBus, RS232, Console, DI/DO, OTG and HDMI. With the installation of 5G NR, Wi-Fi 5/6 modules, the ATC 3752-A6CR can collaborate with CPS for AI model re-training, making it suitable for deployment in sophisticated applications such as ADAS/ANPR/Alaided ITS/Construction, etc. In harsh environments, the ATC 3752-A6CR can operate at a wide temperature range of -25~70°C and meet the MIL-STD-810H military standard for anti-vibration and shock. For regulation, the ATC 3752-A6CR is certified by CE/FCC Class A, UKCA and EN50155.

## Specifications

### NVIDIA® Jetson AGX™ Orin SOM

- 32GB 256-bit LPDDR5, 204.8 GB/s (ATC 3750-A6CR)
  - 8 x cores | 2 Cortex-A78AE CPU clusters (4 cores/cluster), 2.2 GHz
  - 1792 CUDA® cores, 56 Tensor cores, 108 Sparse TOPS, 939 MHz
  - 200 INT8 Sparse TOPS
  - 2 x NVDLA v2.0 engines: 1.4 GHz | 46 TOPS each (Sparse INT8)
- 64 GB 256-bit LPDDR5, 204.8 GB/s (ATC 3750-A6CR-64)
  - 12 x cores | 3 Cortex-A78AE CPU clusters (4 cores/cluster), 2.2 GHz
  - 2048 CUDA® cores, 64 Tensor cores, 170 Sparse TOPS, 1.3 GHz
  - 275 INT8 Sparse TOPS
  - 2 x NVDLA v2.0 engines: 1.6 GHz | 52.5 TOPS each (Sparse INT8)
- Video Encode: 2 x 4K60 | 4 x 4K30 | 8 x 1080p60 (H.265)
- Video Decode: 1 x 8K30 | 3 x 4K60 | 6 x 4K30 | 12 x 1080p60 (H.265)
- OpenGL 4.6+, OpenGL ES 3.2, and Vulkan 1.2+, CUDA 10.2+
- NVIDIA® JetPack 5.0.2

### Storage

- 64GB eMMC 5.1 flash storage, 200 MHz (HS400 or HS533)
- 1 x Accessible SD card (SDXC-I/ UHS-I, SD3.0)
- 1 x M.2 2280 Key M (PCIe4.0 x4), NVMe SSD

### Expansion

- 1 x Full size mPCIe socket (PCIe 4.0, USB 2.0)
- 1 x M.2 3042/3052 Key B socket (USB 3.2/2.0), 2 x Nano SIM slots
- 1 x M.2 3030 Key E socket (PCIe4.0, USB2.0) for Wi-Fi 5/6

### Display

- 1 x HDMI 2.0A/B, up to 3840 x 2160@60Hz
- G-Sensor

- 3D accelerometer and 3D gyroscope, ST LSM6DSLTR

### PoE+

- 6-port GbE
- 9Kbyte Jumbo frame
- IEEE 802.3af/at, total 80W
- IEEE1588 supported
- PSE ON/OFF & Watt monitoring
- GIGA LAN Switch: KSZ9477STXI
- X-coded connector

### USB

- 2 x USB 3.2 Gen 2:
  - Host Type-A connector
  - 5V@900mA each
  - Up to 10Gbit/s link speed & compliance with USB 2.0 (LS/FS/HS link speed)
- 1 x OTG, micro-USB

### Serial Port

- 2 x Full RS232 (DB9)
- 1 x Console (Tx, Rx)
- RS232 working voltage, +- 9V, baud rate up to 115.2kb/s
- DI/DO
- 4-bit input
- Source: 9~36VDC (12V@1.1mA/24V@2.2mA)
  - External: 0~33VDC pull-high, high-level, 3.3 - 33 VDC; low-level, 0 - 2 VDC
- 4-bit output
  - Source: 9~36VDC (nominal 35mA@24V)
  - External: 5~27VDC pull-high, sink current w/ 220mA for each bit, 500mA max (@25C)
- Source or external can be selected by software (default: source type)

## Dimension Drawing

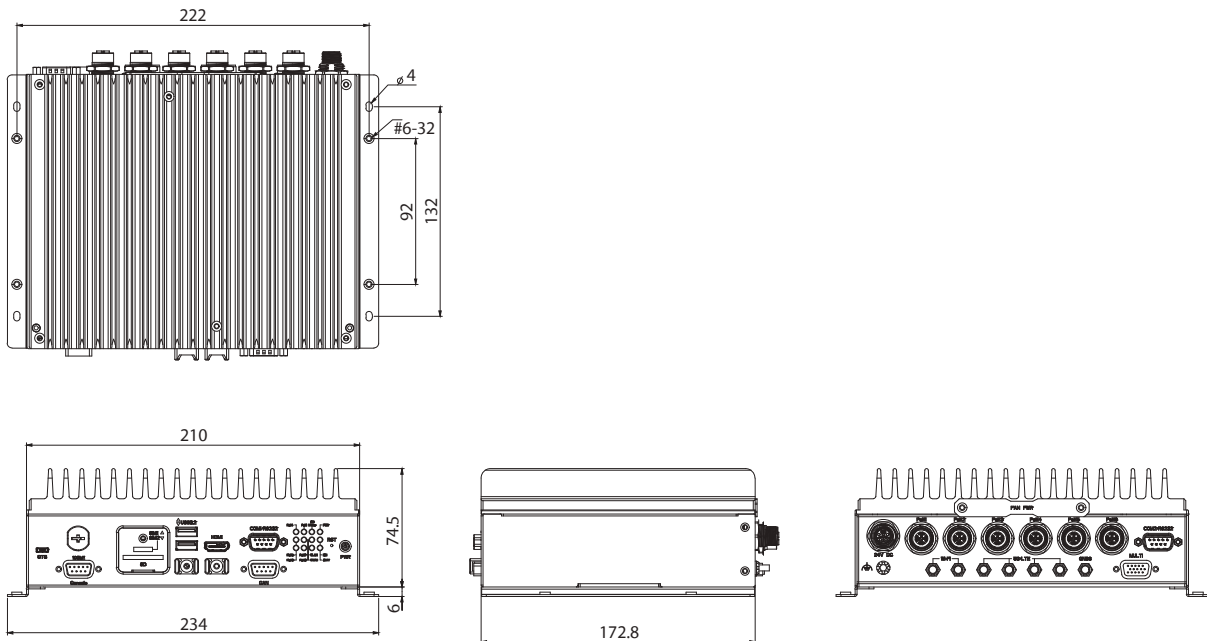

### CAN Bus

- 2 x CAN 2.0A/2.0B
- IEC 61000-4-2 Electrostatic Discharge (ESD):  $\pm 8\text{KV}/15\text{KV}$  (contact/air)
- 2.5KV isolated

### 10GbE, X-coded (optional)

- Ethernet PHY: Marvell AQR113C-BO-I
- 10GBASE-T/5GBASE-T/2.5GBASE-T/1000BASE-T/100BASE-TX/10BASE-T
- Compliant with IEEE 802.3az
- 9Kbyte Jumbo frame
- IEEE1588 supported

### Watch Dog Timer

- Yes, through MCU

### Remote ATX PWR & Reset Trigger

- Reserved, wafer-type

### GNSS

- u-blox NEO-M9N GNSS module for GPS/Gloness/QZSS/Galileo/Beidou
- Optional DR (Dead Reckoning) Function

### Power Supply (K-coded)

- Nominal voltage: 24VDC (14.4V~33.6V), K-coded connector
- OCP & UVP (shut down once exceeding 37V)
- Ignition on/off control & programmable on/off delay timer
- Optional for remote power on/off control

### I/O Ports, Front-Plate

- ATX power button
- Reset button
- 12 x LED Indicators
- 2 x USB 3.2 Type A
- Console (DB9)
- 2 x CAN (DB9)
- COM1/RS232 (DB9)
- 2 x Nano SIMs
- 1 x HDMI
- 1 x SD
- 1 x OTG

### I/O Ports, Rear-Plate

- COM2/RS232 (DB9)
- 6 x X-coded (GbE PoE+)
- 1 x Multi (DI/DO, DR signal)
- 1 x SMA for GNSS
- 2 x RP-SMA for Wi-Fi
- 4 x SMA for LTE/5G

- 24VDC-IN

### Dimensions & Weight

- 234.0mm x 172.8mm x 80.5mm (w/ mount bracket), weight: 3.5kg

### Environment

- Operating temperatures:  $-25^{\circ}\text{C}\sim 70^{\circ}\text{C}$  (TDP 15W~60W, fanless, w/ 80W PoE)
- Storage temperatures:  $-40^{\circ}\text{C}\sim 85^{\circ}\text{C}$
- Relative humidity: 10%~95% (non-condensing)

### Vibration & Shock

- Vibration in operating:
  - MIL-STD-810H, 514.8C Procedure 6, Category 4
  - IEC 60068-2-64: 2.0g@5~500 Hz
- Vibration in storage:
  - MIL-STD-810G, 514.6E Procedure 1, Category 24, 7.7g
- Shock:
  - MIL-STD-810G, 516.6 Procedure I, trucks and semi-trailers=40g
  - Crash hazard: Procedure V, ground equipment=75g

### Certifications

- CE approval, FCC Class A, UKCA, EN50155 Certified

### Operating System

- NEXCOM Aided Linux (NAL) w/ Jetpack 5.1.1 integrated
- NEXCOM custom functions (GNSS, 5G/NR, 6-axis sensor, MCU control)
- Ubuntu 20.04 (L4T 35.1, Linux Kernel 5.10)

### External Cable (optional)

- DB15 multi-port adapter cable, 20cm

## Ordering Information

- **ATC 3750-A6CR (P/N: 10AT0375002X0)**  
NVIDIA® Jetson AGX™ Orin SOM, 32GB LPDDR5, 64GB eMMC, 6 x PoE+ (X-coded), 2 x USB 3.2, 2 x RS232, OTG/Console, Rail, 24VDC
- **ATC 3750-A6CR-64 (P/N: 10AT0375003X0)**  
NVIDIA® Jetson AGX™ Orin SOM, 64GB LPDDR5, 64GB eMMC, PoE+ (X-coded), 2 x USB 3.2, 2 x RS232, OTG/Console, Rail, 24VDC
- **VTK PWA20-01 (P/N: 10VK00PWA01X0)**  
24V DC/DC converter, 200W, w/ power isolation, A-coded to K-code adapter cable