

PCM-24R2GL

2-Port Gigabit Ethernet, Intel® I350, mPCIe, RJ45

NEW

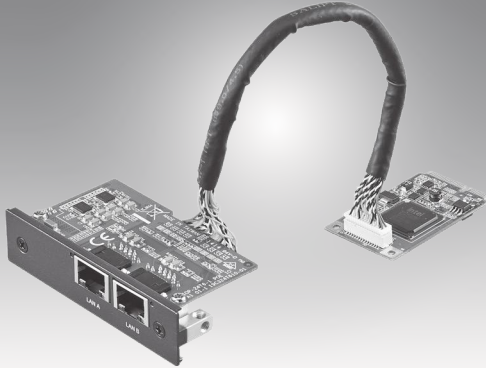

Features

- Meets Advantech iDoor technology standard
- PCI Express® Mini card specification revision 1.2 compliant
- Real-time Ethernet with hardware based precision time protocol
- Achieves time synchronization for device or system
- Supports 2 Gigabit Ethernet MAC controller and PHY ports
- Supports 32/64-bit Windows 7/8, Linux 2.4/2.6
- Supports embedded automation PC UNO-2200/2400 series
- Supports control DIN-Rail PC UNO-1200/1300/1400 series
- Supports control cabinet PC UNO-3200/3300/3400 series
- Supports control panel computers TPC-xx81/xx82 series
- Supports thin client panel computers TPC-xx51 series

Introduction

The PCM-24 series are communication modules from Advantech iDoor Technology. They are all compatible with PCI Express® Mini Card Specification Revision 1.2, including isolated / non-isolated RS-232/422/485 communication cards for automation control, Wi-Fi/3G/GPS/GSM/LTE wireless communication models for data exchange for management and machine level automation applications; ZigBee module serves as an IoT terminal or controller and PoE function for smart cameras in detection-inspection-production applications. This is a flexible design that enables customers to customize their features with iDoor Technology.

Specifications

General

- **Bus Type** PCI Express Mini Card Revision 1.2
- **Certification** CE, FCC class A
- **Connectors** 2 x RJ45
- **Dimensions** Module: 51 x 30 x 12.4 mm (2" x 1.18" x 0.49")
I/O Plate: 81 x 19.4 x 41 mm (3.19" x 0.76" x 1.61")

Communications

- **LAN Controller** Intel® I350-AM2 LAN Controller
- **Speed** 10/100/1000 Mbps
- **Support** IEEE 1588

Power Requirements

- **Power Consumption** Typical: +3.3 V @ 9 W

Protection

- **Isolation Protection** 1,600 V_{DC}
- **ESD Protection** 4 KV (Contact), 8 KV (Air)
- **EFT Protection** 1,000 V

Software

- **OS Support** Microsoft® Windows® XP/7/8/10, Linux 2.4/2.6

Environment

- **Operating Humidity** 5 ~ 95% RH
- **Operating Temperature** 0 ~ 60°C (32 ~ 140°F)
- **Storage Temperature** -20 ~ 80°C (-4 ~ 176°F)

Dimensions

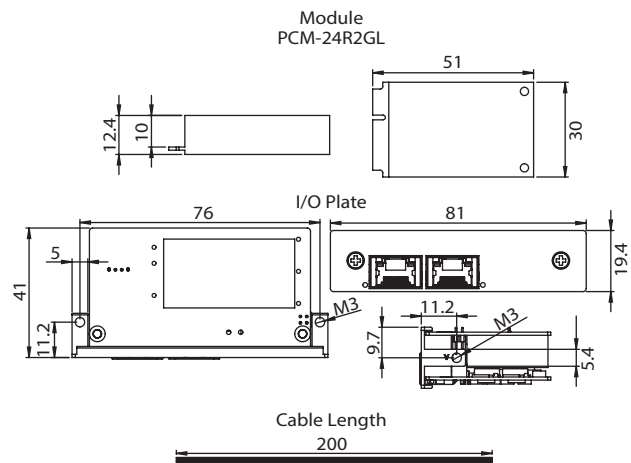

Ordering Information

- **PCM-24R2GL-AE** 2-Port Gigabit Ethernet, Intel® I350, mPCIe, RJ45